

Applications

- Defense & Aerospace
- Broadband Wireless

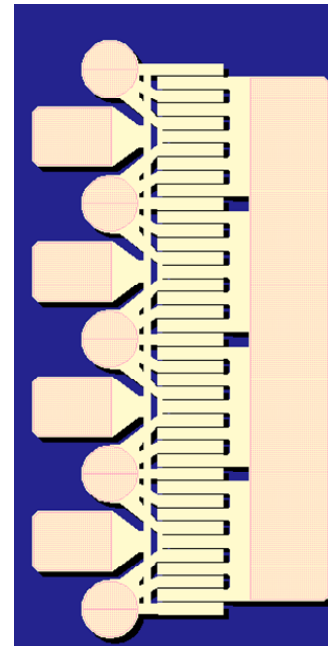

Product Features

- Frequency Range: DC - 18 GHz
- 43 dBm Nominal P_{SAT} at 3 GHz
- 78.3% Maximum PAE
- 18 dB Nominal Power Gain at 3 GHz
- Bias: $V_D = 12 - 32$ V, $I_{DQ} = 100 - 500$ mA
- Technology: TQGaN25 on SiC
- Chip Dimensions: 0.82 x 1.44 x 0.10 mm

Functional Block Diagram

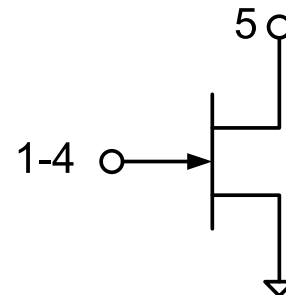

General Description

The TriQuint TGF2023-2-05 is a discrete 5 mm GaN on SiC HEMT which operates from DC-18 GHz. The TGF2023-2-05 is designed using TriQuint's proven TQGaN25 production process. This process features advanced field plate techniques to optimize microwave power and efficiency at high drain bias operating conditions.

The TGF2023-2-05 typically provides 43.0 dBm of saturated output power with power gain of 18 dB at 3 GHz. The maximum power added efficiency is 78.3 % which makes the TGF2023-2-05 appropriate for high efficiency applications.

Lead-free and RoHS compliant

Pad Configuration

Pad No.	Symbol
1-4	V_G / RF IN
5	V_D / RF OUT
Backside	Source / Ground

Ordering Information

Part	ECCN	Description
TGF2023-2-05	3A001b.3.b	25 Watt GaN HEMT

Absolute Maximum Ratings

Parameter	Value
Drain to Gate Voltage (V_{DG})	100 V
Drain Voltage (V_D)	40 V
Gate Voltage Range (V_G)	-50 to 0 V
Drain Current (I_D)	5 A
Gate Current (I_G)	-5 to 14 mA
Power Dissipation (P_D)	See graph on pg.3.
CW Input Power (P_{IN})	+37 dBm
Channel Temperature (T_{CH})	275 °C
Mounting Temperature	320 °C
Storage Temperature	-65 to 150 °C

Operation of this device outside the parameter ranges given above may cause permanent damage. These are stress ratings only, and functional operation of the device at these conditions is not implied.

Recommended Operating Conditions

Parameter	Value
Drain Voltage Range (V_D)	28 – 32 V
Drain Quiescent Current (I_{DQ})	250 mA
Drain Current Under RF Drive (I_D)	1.5 A (Typ.)
Gate Voltage (V_G)	-3.0 V (Typ.)
Channel Temperature (T_{CH})	225 °C (Max.)

Electrical specifications are measured at specified test conditions. Specifications are not guaranteed over all recommended operating conditions.

RF Characterization – Optimum Power Tune

Test conditions unless otherwise noted: T = 25 °C, Bond wires included. Measured data provided by Modelithics.

Parameter	Typical Value				Units
	12V	25V	100V	250V	
Frequency (F)	3				GHz
Drain Voltage (V_D)	12	12	28	28	V
Bias Current (I_{DQ})	100	250	100	250	mA
Input Power (P_{in})	23	23	25	25	dBm
Output Power (P_{out})	39.1	39.2	43	43	dBm
Power Added Efficiency (PAE)	78.2	60.7	62.7	62.9	%
Power Gain (Gain)	16.1	16.2	18	18	dB
Parallel Resistance ⁽¹⁾ (R_p)	32.4	32.4	72.2	73.6	Ω -mm
Parallel Capacitance ⁽¹⁾ (C_p)	1.14	1.14	0.43	0.35	pF/mm
Load Reflection Coefficient ⁽²⁾ (Γ_L)	0.84 \angle 173°	0.84 \angle 173°	0.65 \angle 165°	0.62 \angle 166°	--

Notes:

1. Large signal equivalent output network (normalized).
2. Characteristic Impedance (Z_0) = 50 Ω .

RF Characterization – Optimum Efficiency Tune

Test conditions unless otherwise noted: T = 25 °C, Bond wires included. Measured data provided by Modelithics.

Parameter	Typical Value				Units
	12V	25V	100V	250V	
Frequency (F)	3				GHz
Drain Voltage (V_D)	12	12	28	28	V
Bias Current (I_{DQ})	100	250	100	250	mA
Input Power (P_{in})	23	23	25	25	dBm
Output Power (P_{out})	36.5	36.6	40.3	40.4	dBm
Power Added Efficiency (PAE)	78.3	77.8	75.9	75.6	%
Power Gain (Gain)	13.5	13.6	15.3	15.4	dB
Parallel Resistance ⁽¹⁾ (R_p)	92.7	92.7	231	223	Ω -mm
Parallel Capacitance ⁽¹⁾ (C_p)	0.82	0.82	0.55	0.54	pF/mm
Load Reflection Coefficient ⁽²⁾ (Γ_L)	0.79 \angle 160°	0.79 \angle 160°	0.78 \angle 143°	0.77 \angle 143°	--

Notes:

1. Large signal equivalent output network (normalized).
2. Characteristic Impedance (Z_0) = 50 Ω .

RF Characterization – Optimum Power Tune

Test conditions unless otherwise noted: T = 25°C, Bond wires included. Measured data provided by Modelithics.

Parameter	Typical Value				Units
Frequency (F)	6				GHz
Drain Voltage (V _D)	12	12	28	28	V
Bias Current (I _{DQ})	100	250	100	250	mA
Input Power (P _{in})	32	32	33	33	dBm
Output Power (P _{out})	40.2	40.3	43.3	43.2	dBm
Power Added Efficiency (PAE)	63.0	63.1	58.4	56.5	%
Power Gain (Gain)	8.2	8.3	10.3	10.2	dB
Parallel Resistance ⁽¹⁾ (R _p)	33.2	33.2	39.3	35.3	Ω·mm
Parallel Capacitance ⁽¹⁾ (C _p)	-0.52	-0.52	0.15	0.14	pF/mm
Load Reflection Coefficient ⁽²⁾ (Γ _L)	0.83∠-173°	0.83∠-173°	0.74∠176°	0.76∠177°	--

Notes:

1. Large signal equivalent output network (normalized).
2. Characteristic Impedance (Z₀) = 50 Ω.

RF Characterization – Optimum Efficiency Tune

Test conditions unless otherwise noted: T = 25°C, Bond wires included. Measured data provided by Modelithics.

Parameter	Typical Value				Units
Frequency (F)	6				GHz
Drain Voltage (V _D)	12	12	28	28	V
Bias Current (I _{DQ})	100	250	100	250	mA
Input Power (P _{in})	32	32	33	33	dBm
Output Power (P _{out})	39.4	39.4	42.4	42.9	dBm
Power Added Efficiency (PAE)	69.5	69.1	74.2	73.1	%
Power Gain (Gain)	7.4	7.4	9.4	9.9	dB
Parallel Resistance ⁽¹⁾ (R _p)	23.4	23.4	57.4	47.7	Ω·mm
Parallel Capacitance ⁽¹⁾ (C _p)	-0.11	-0.11	0.55	0.57	pF/mm
Load Reflection Coefficient ⁽²⁾ (Γ _L)	0.83∠-179°	0.83∠-179°	0.83∠167°	0.83∠169°	--

Notes:

1. Large signal equivalent output network (normalized).
2. Characteristic Impedance (Z₀) = 50 Ω.

RF Characterization – Optimum Power Tune

Test conditions unless otherwise noted: T = 25°C, Bond wires included. Measured data provided by Modelithics.

Parameter	Typical Value			Units
Frequency (F)	10			GHz
Drain Voltage (V _D)	12	28	28	V
Bias Current (I _{DQ})	250	100	250	mA
Input Power (P _{in})	35	35	35	
Output Power (P _{out})	39.1	41.7	41.9	dBm
Power Added Efficiency (PAE)	41.8	47.9	48.3	%
Power Gain (Gain)	4.1	6.7	6.9	dB
Parallel Resistance ⁽¹⁾ (R _p)	79.4	32.0	32.0	Ω·mm
Parallel Capacitance ⁽¹⁾ (C _p)	-0.29	-0.19	-0.19	pF/mm
Load Reflection Coefficient ⁽²⁾ (Γ _L)	0.82∠-163°	0.80∠-175°	0.80∠-175°	--

Notes:

1. Large signal equivalent output network (normalized).
2. Characteristic Impedance (Z₀) = 50 Ω.

RF Characterization – Optimum Efficiency Tune

Test conditions unless otherwise noted: T = 25°C, Bond wires included. Measured data provided by Modelithics.

Parameter	Typical Value			Units
Frequency (F)	10			GHz
Drain Voltage (V _D)	12	28	28	V
Bias Current (I _{DQ})	250	100	250	mA
Input Power (P _{in})	35	35	35	
Output Power (P _{out})	39.0	41.6	41.8	dBm
Power Added Efficiency (PAE)	42.4	48.9	49.2	%
Power Gain (Gain)	4.0	6.6	6.8	dB
Parallel Resistance ⁽¹⁾ (R _p)	66.4	29.3	30.5	Ω·mm
Parallel Capacitance ⁽¹⁾ (C _p)	-0.29	-0.13	-0.16	pF/mm
Load Reflection Coefficient ⁽²⁾ (Γ _L)	0.81∠-165°	0.80∠-177°	0.80∠-176°	--

Notes:

1. Large signal equivalent output network (normalized).
2. Characteristic Impedance (Z₀) = 50 Ω.

Thermal and Reliability Information ⁽¹⁾

Parameter	Test Conditions	Value	Units
Thermal Resistance, θ_{JC} (No RF Drive)	$V_D = 28\text{ V}$, $I_D = 0.5\text{ A}$, $P_D = 14\text{ W}$, $T_{\text{baseplate}} = 70^\circ\text{C}$	5.79	$^\circ\text{C/W}$
Channel Temperature, T_{CH} (No RF Drive)		151	$^\circ\text{C}$
Median Lifetime, T_M (No RF Drive)		1.57×10^9	Hrs
Thermal Resistance, θ_{JC} (Under RF Drive)	$V_D = 28\text{ V}$, $I_D = 1.54\text{ mA}$, $P_{OUT} = 43.9\text{ dBm}$, $P_D = 18\text{ W}$, $T_{\text{baseplate}} = 70^\circ\text{C}$	6.09	$^\circ\text{C/W}$
Channel Temperature, T_{CH} (Under RF Drive)		180	$^\circ\text{C}$
Median Lifetime, T_M (Under RF Drive)		7.99×10^7	Hrs

Notes:

- Assumes eutectic attach using 1mil thick 80/20 AuSn mounted to a 10 mil CuMo Carrier Plate.

Median Lifetime

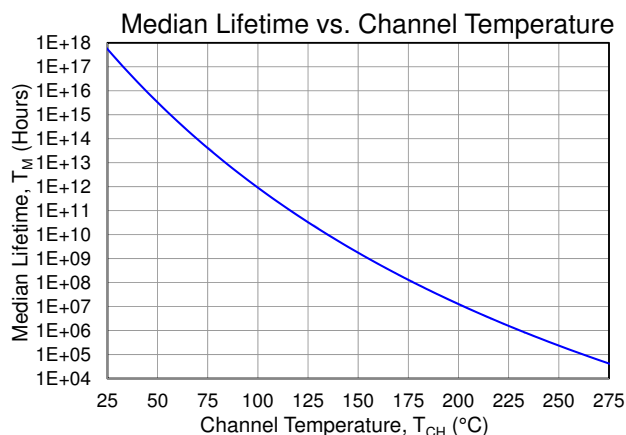

Thermal Resistance

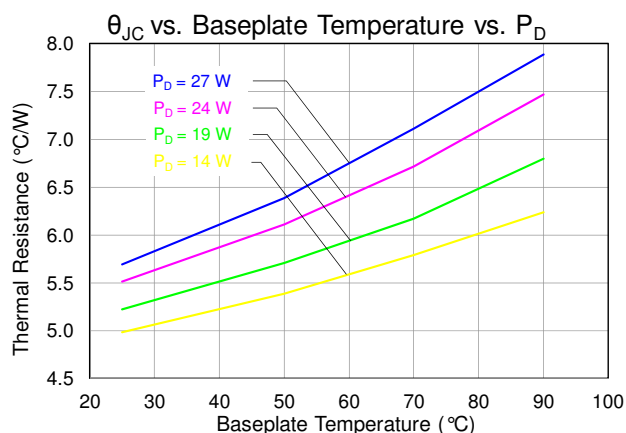

Maximum Gain Performance

Measured data provided by Modelithics.

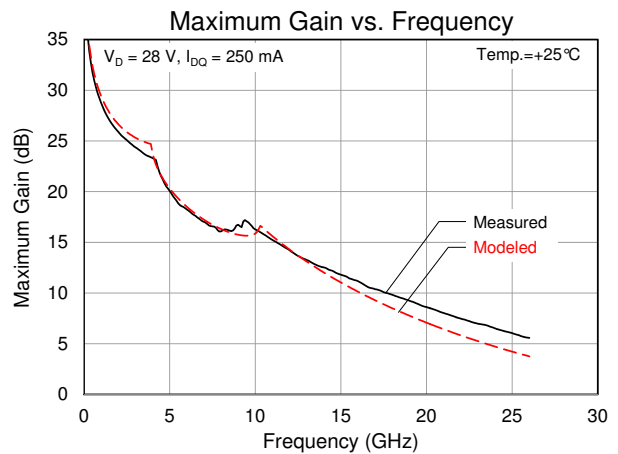
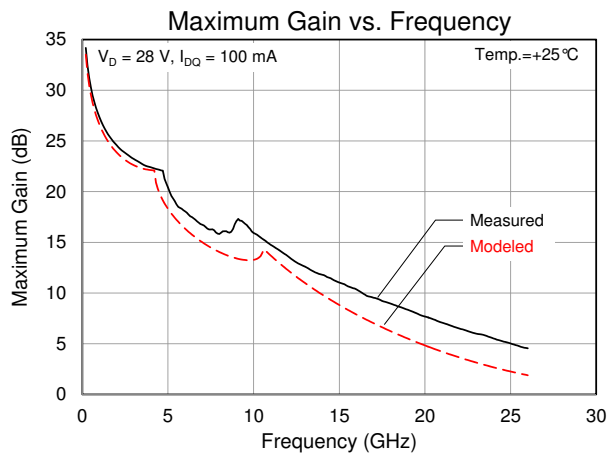
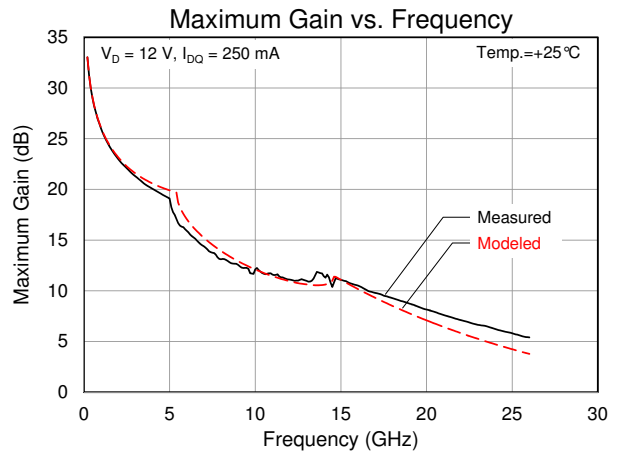
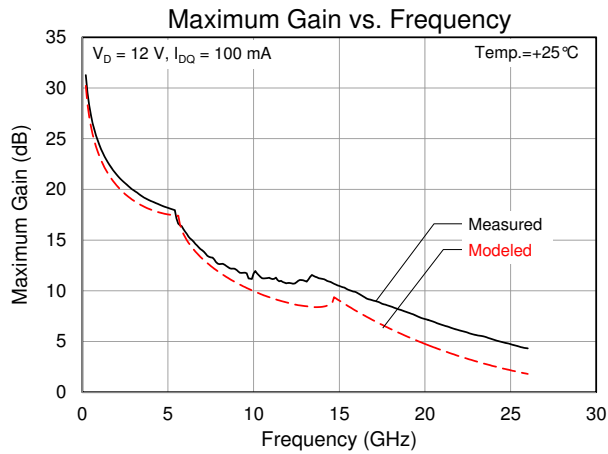

Load Pull Contours

Load pull signal: 10%, 100 μ s pulses. Bond wires included. Measured data provided by Modelithics.

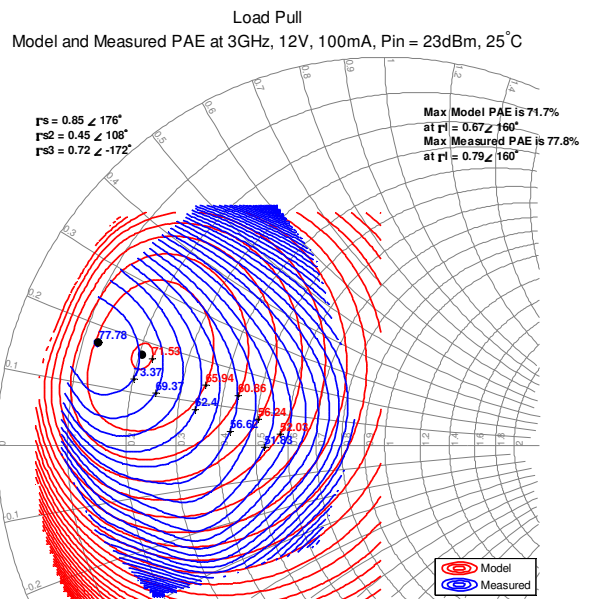
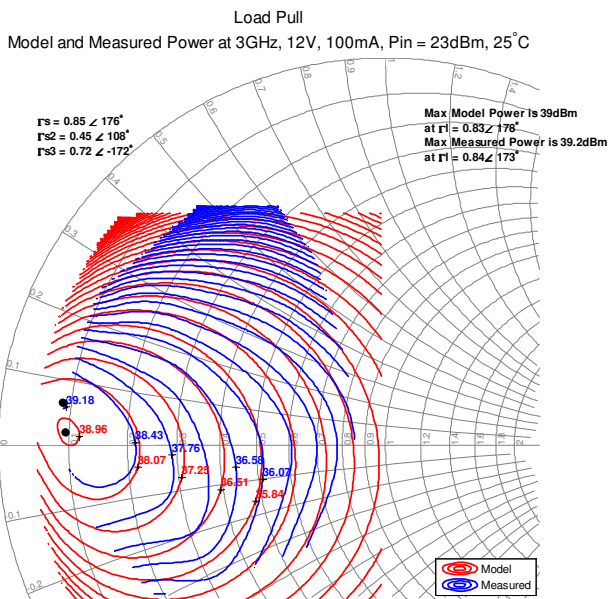
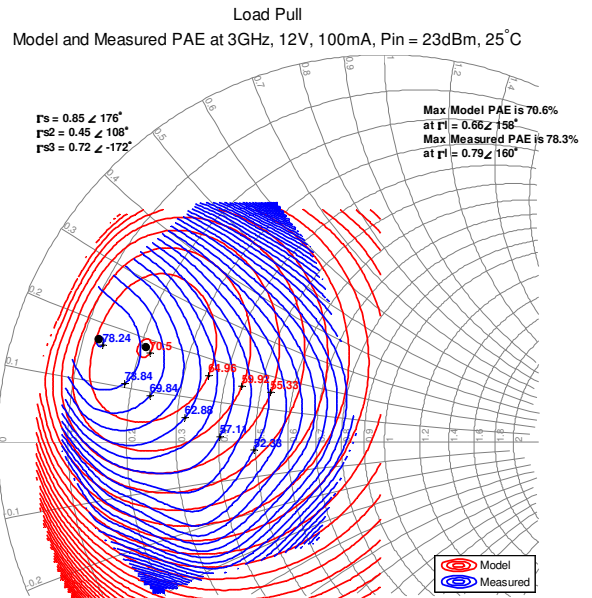
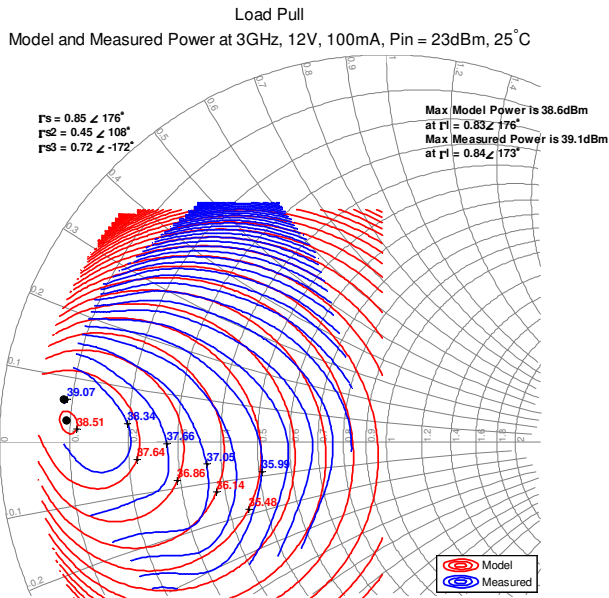

Load Pull Contours

Load pull signal: 10%, 100 μ s pulses. Bond wires included. Measured data provided by Modelithics.

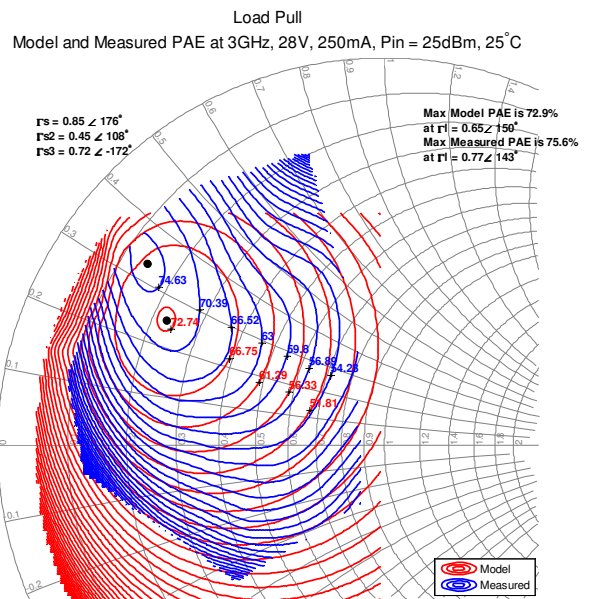
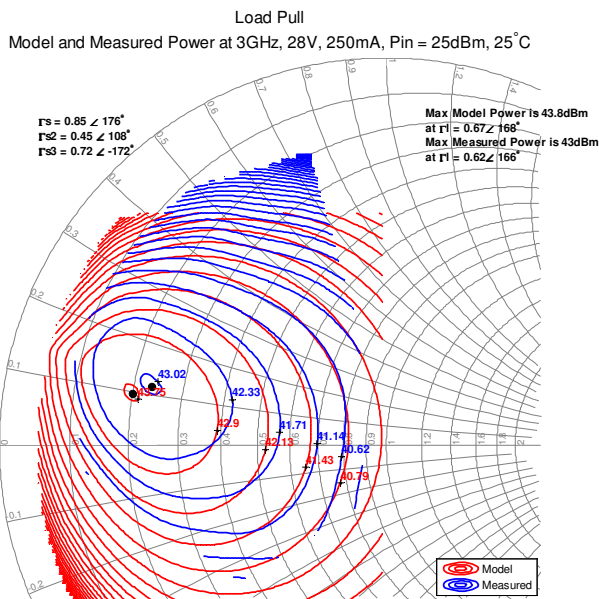
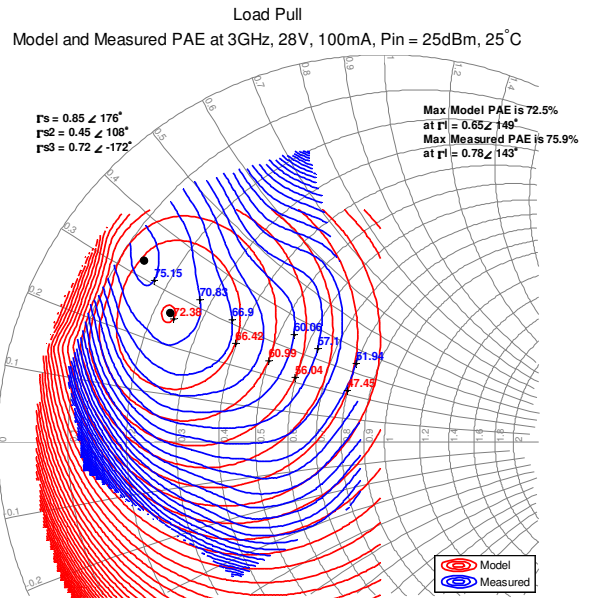
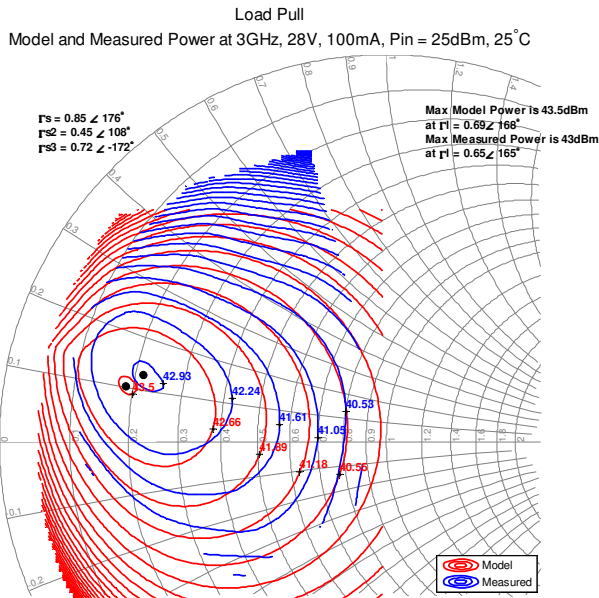

Load Pull Contours

Load pull signal: 10%, 100 μ s pulses. Bond wires included. Measured data provided by Modelithics.

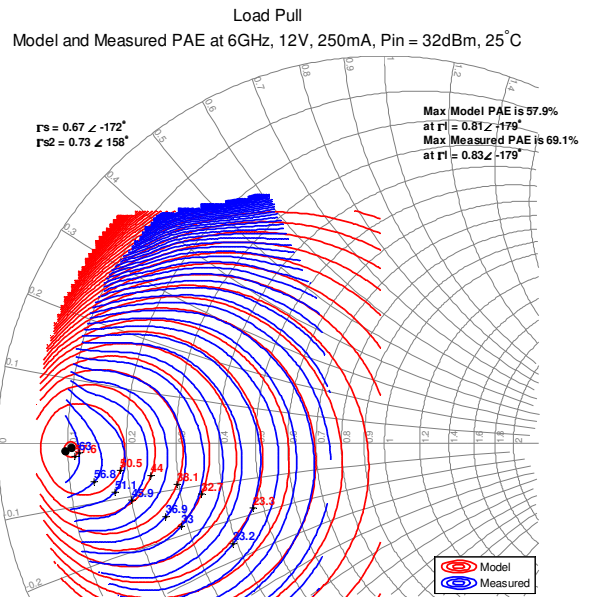
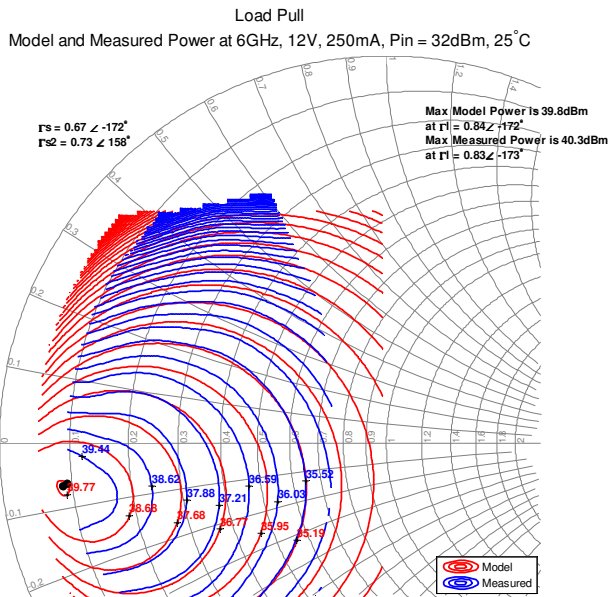
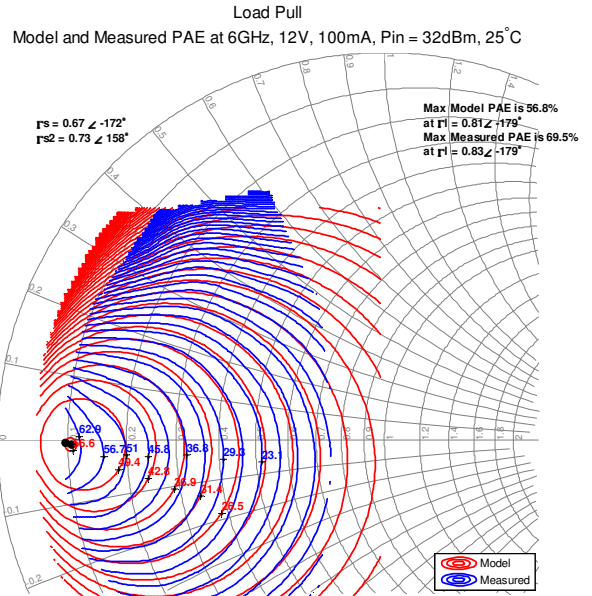
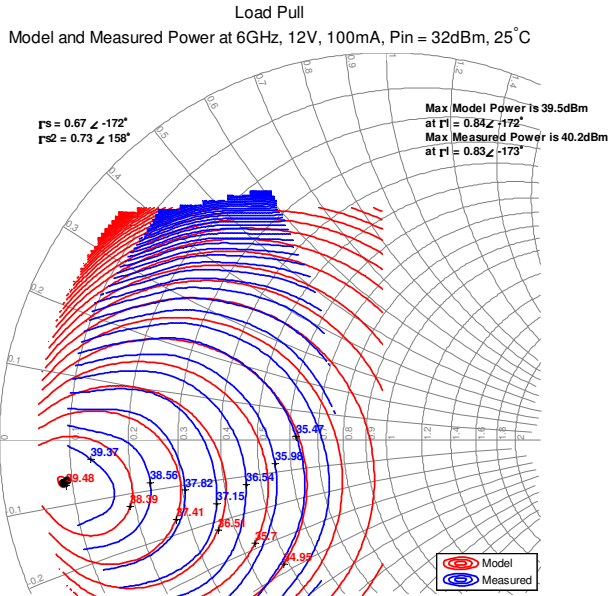

Load Pull Contours

Load pull signal: 10%, 100 μ s pulses. Bond wires included. Measured data provided by Modelithics.

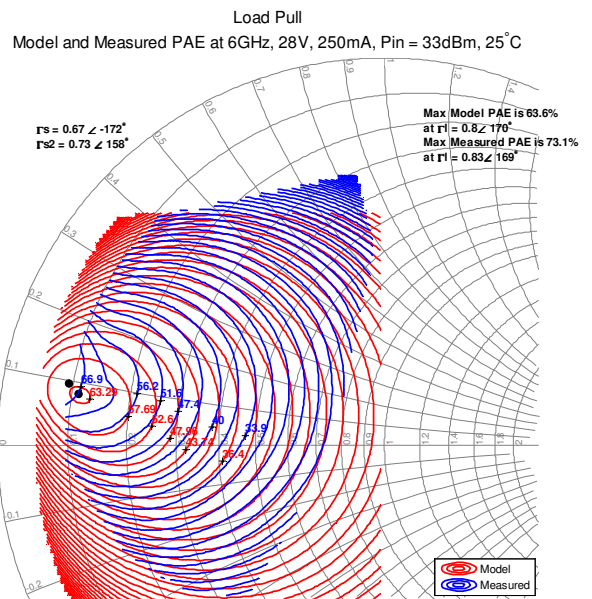
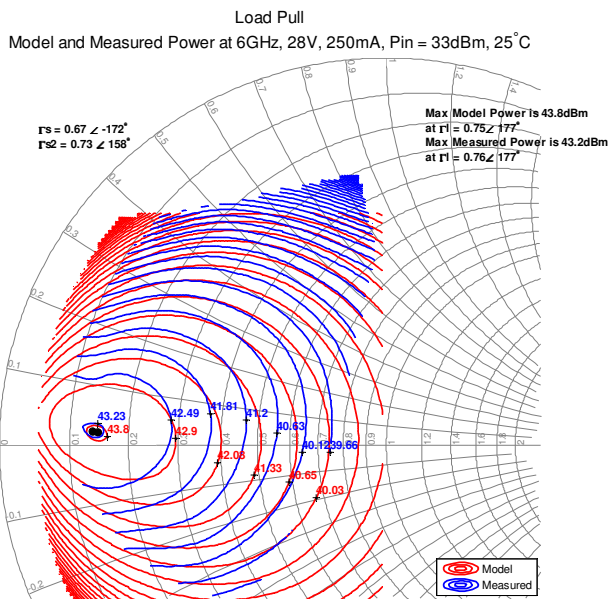
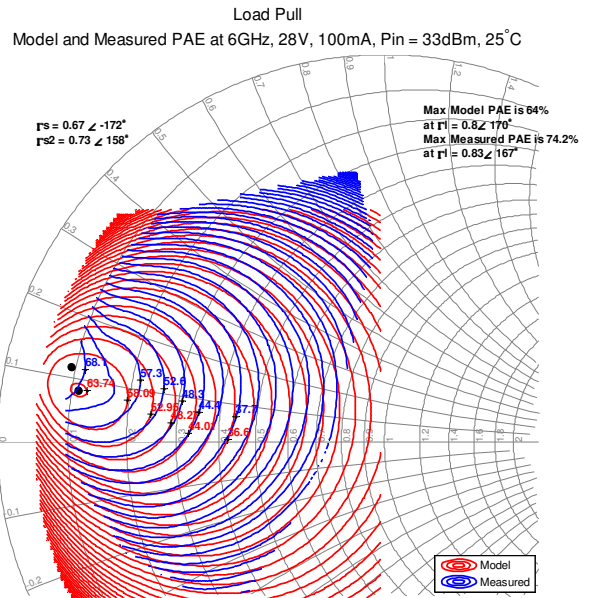
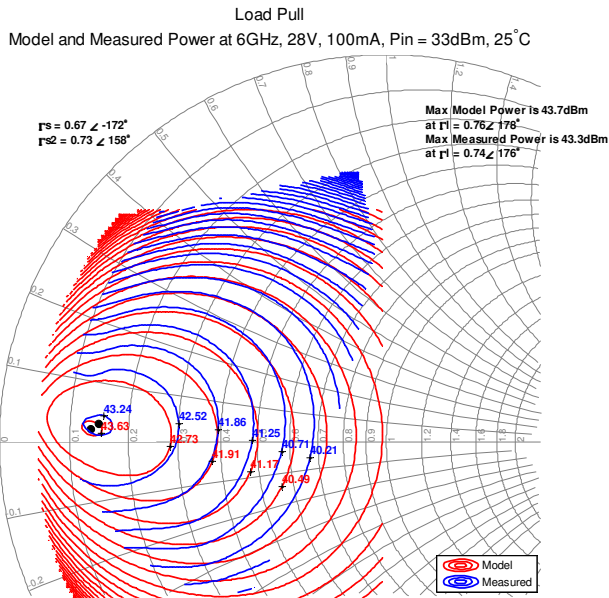

Load Pull Contours

Load pull signal: 10%, 100 μ s pulses. Bond wires included. Measured data provided by Modelithics.

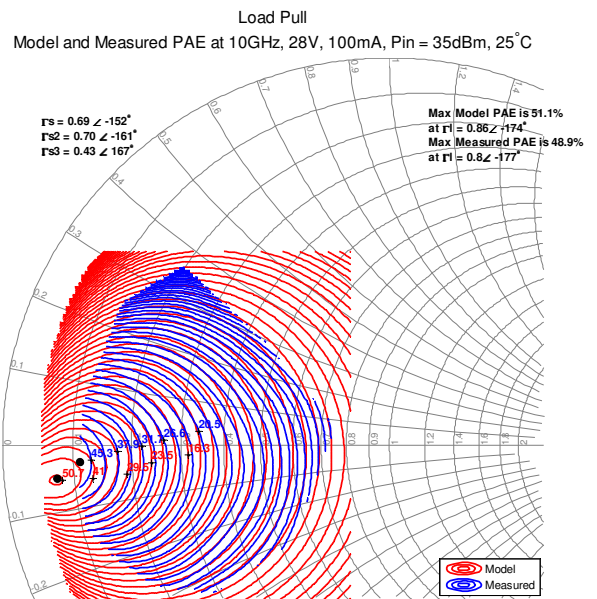
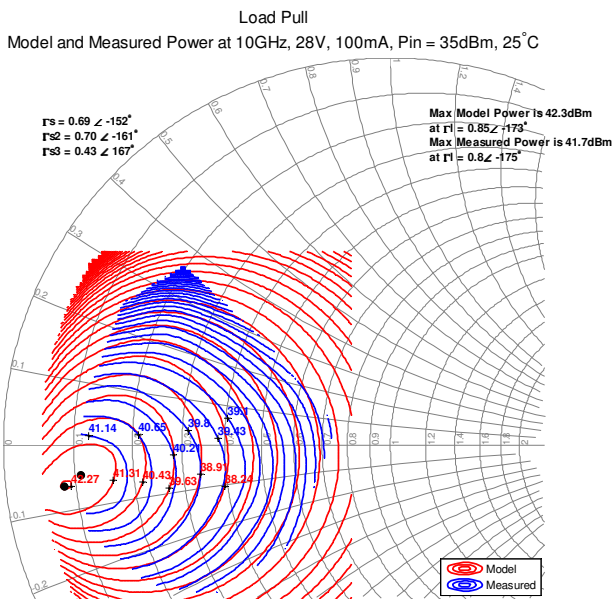
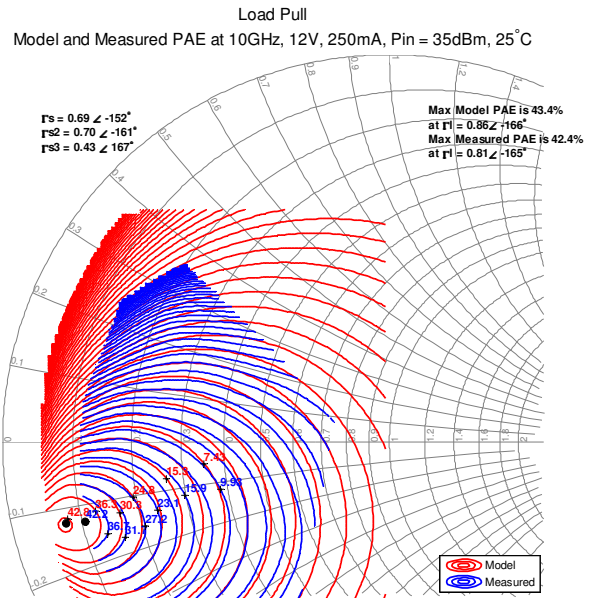
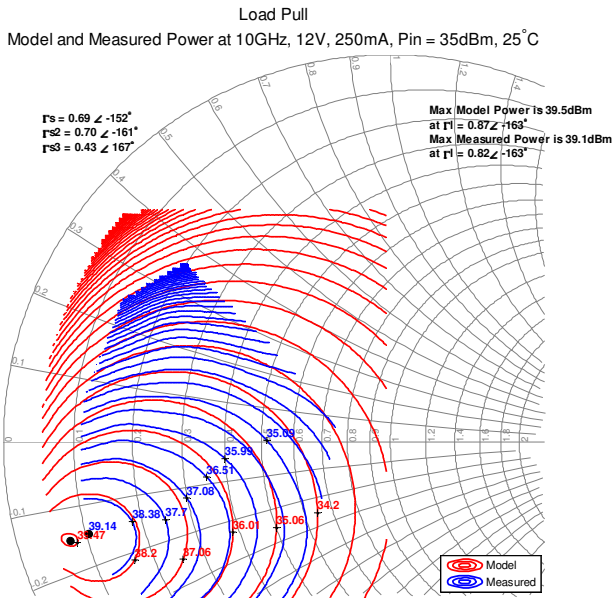

Load Pull Contours

Load pull signal: 10%, 100 μ s pulses. Bond wires included. Measured data provided by Modelithics.

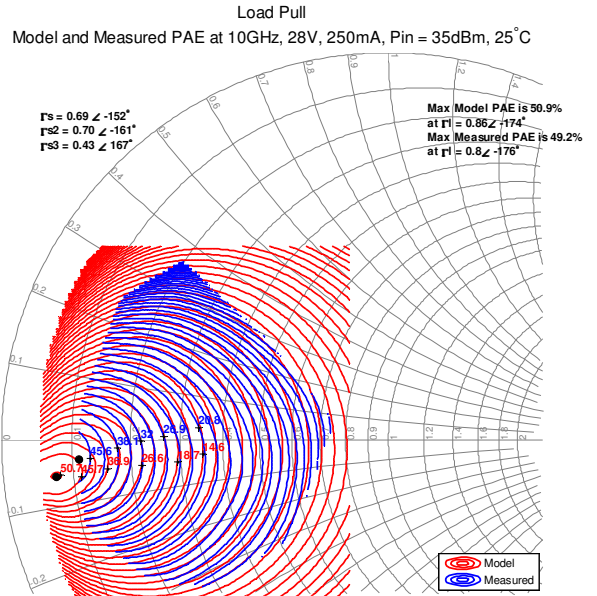
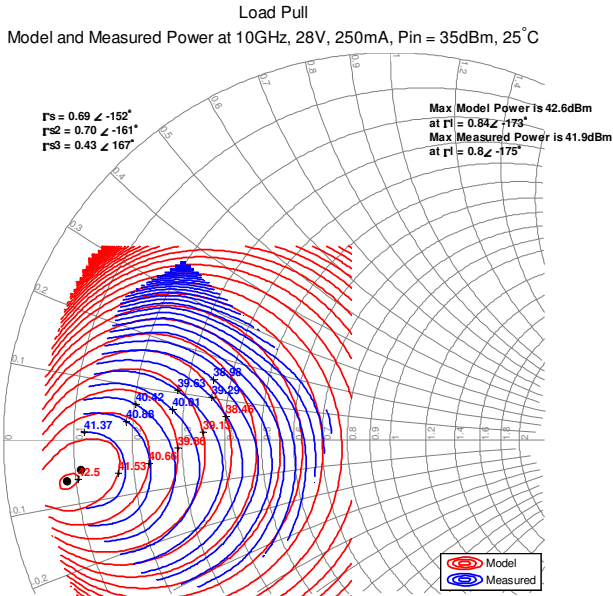

Power Tuned Data

Measured data provided by Modelithics.

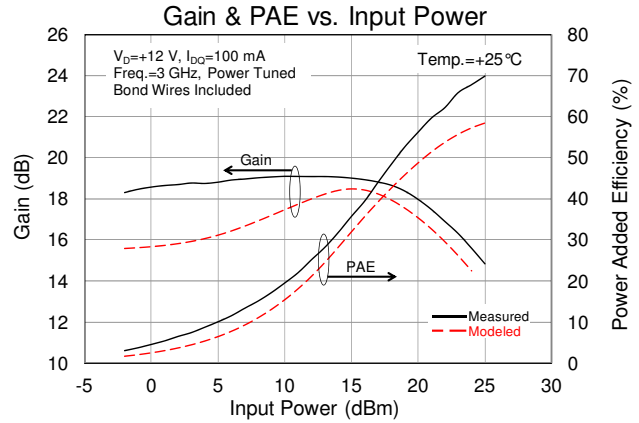
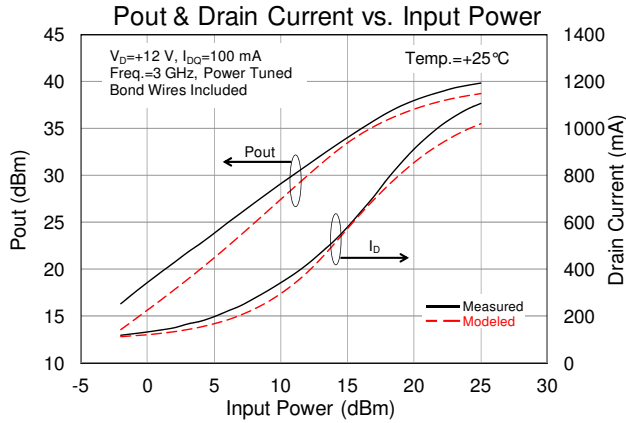

Source Γ : fo: $0.85\angle 176^\circ$, 2fo: $0.45\angle 108^\circ$, 3fo: $0.72\angle -172^\circ$
 Load Γ : fo: $0.84\angle 171^\circ$, 2fo: $0.84\angle 134^\circ$, 3fo: $0.79\angle 100^\circ$

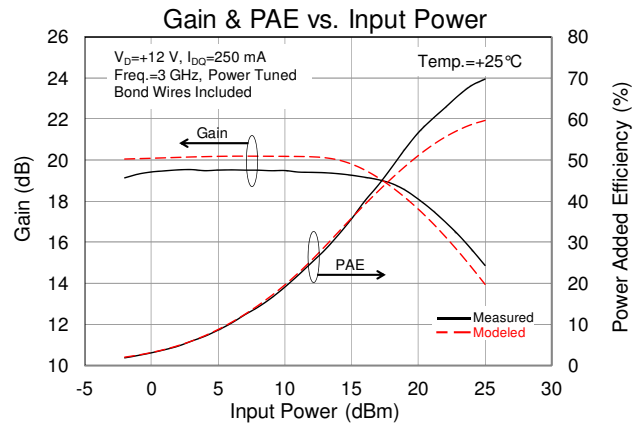
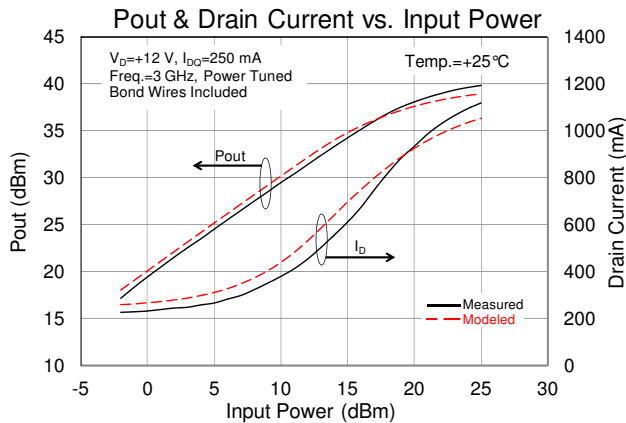

Source Γ : fo: $0.85\angle 176^\circ$, 2fo: $0.45\angle 108^\circ$, 3fo: $0.72\angle -172^\circ$
 Load Γ : fo: $0.84\angle 171^\circ$, 2fo: $0.84\angle 134^\circ$, 3fo: $0.79\angle 100^\circ$

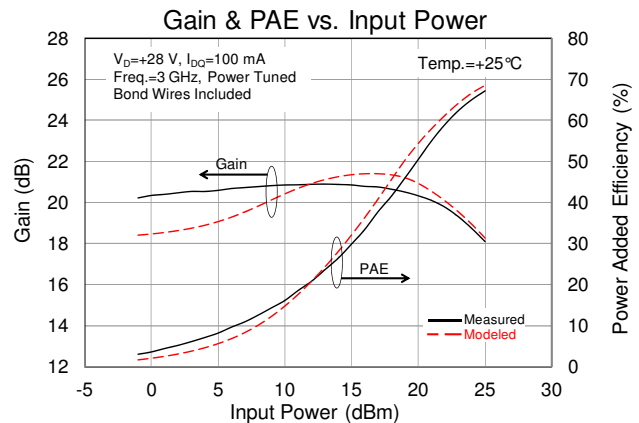
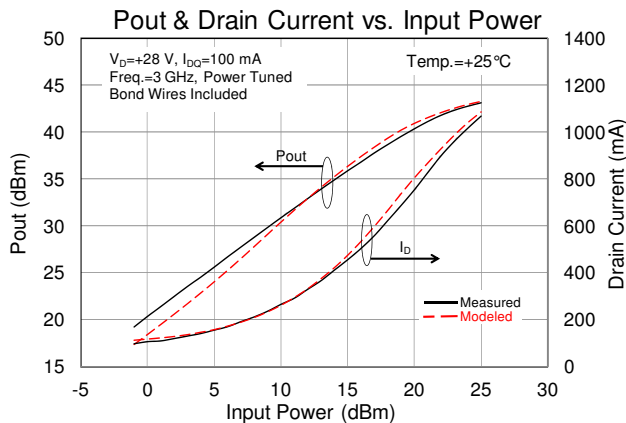

Source Γ : fo: $0.85\angle 176^\circ$, 2fo: $0.45\angle 108^\circ$, 3fo: $0.72\angle -172^\circ$
 Load Γ : fo: $0.62\angle 163^\circ$, 2fo: $0.69\angle 89^\circ$, 3fo: $0.61\angle 23^\circ$

Power Tuned Data

Measured data provided by Modelithics.

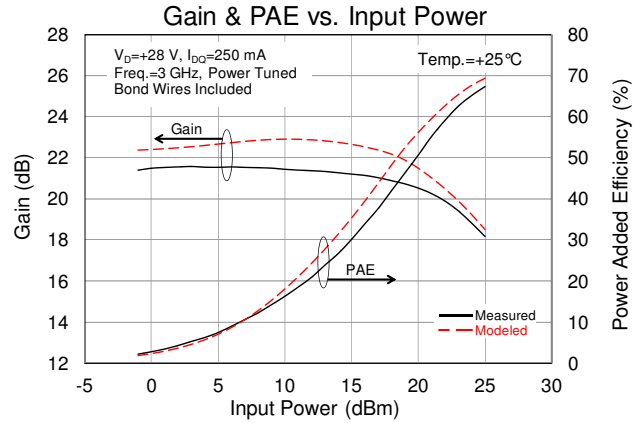
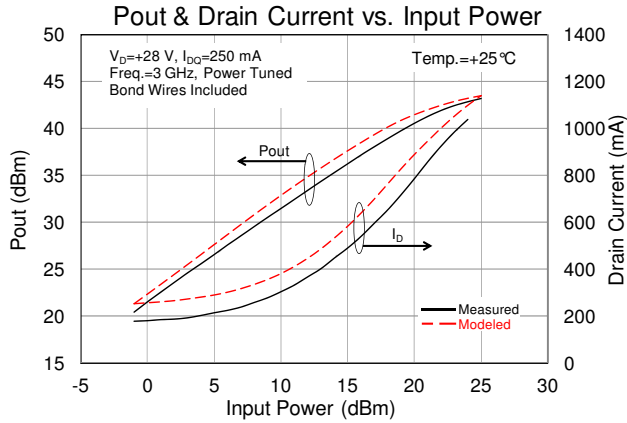

Source Γ : fo: $0.85\angle 176^\circ$, 2fo: $0.45\angle 108^\circ$, 3fo: $0.72\angle -172^\circ$
 Load Γ : fo: $0.62\angle 163^\circ$, 2fo: $0.69\angle 89^\circ$, 3fo: $0.61\angle 23^\circ$

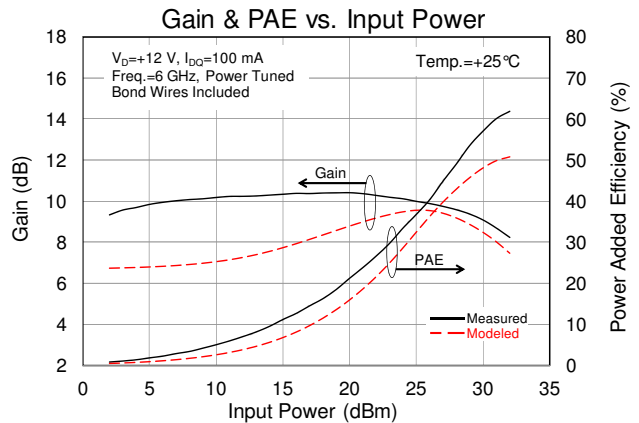
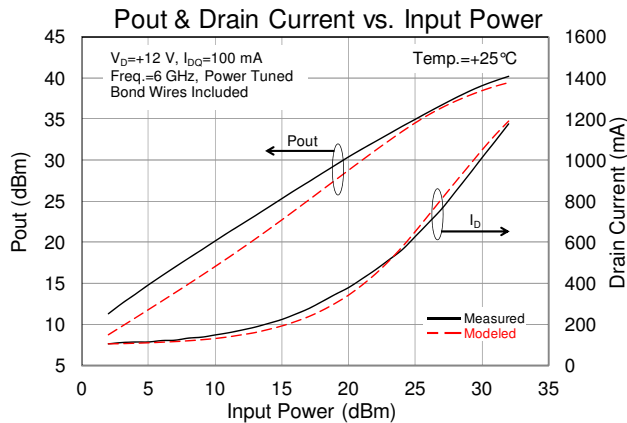

Source Γ : fo: $0.67\angle -172^\circ$, 2fo: $0.73\angle 158^\circ$, 3fo: 0
 Load Γ : fo: $0.83\angle -173^\circ$, 2fo: $0.70\angle 175^\circ$, 3fo: 0

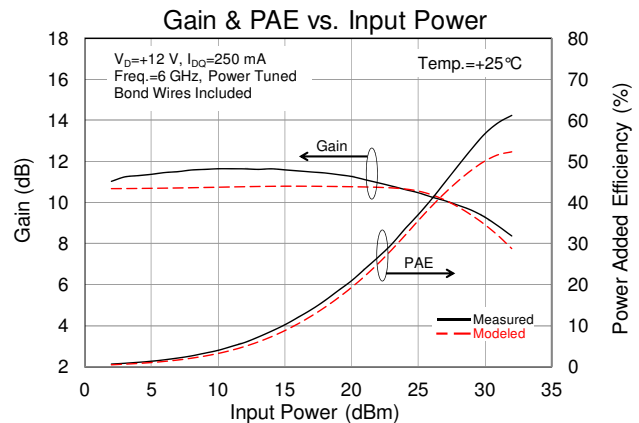
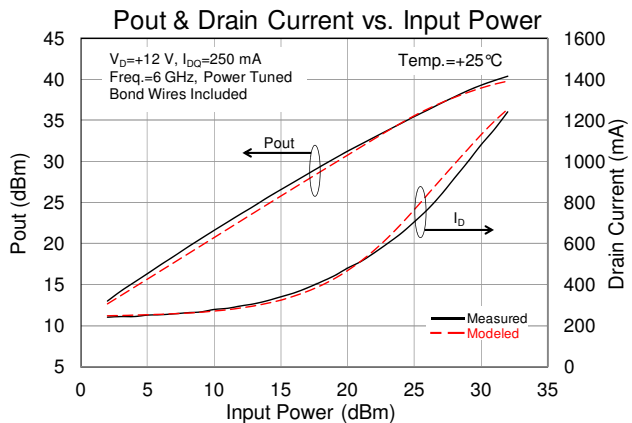

Source Γ : fo: $0.67\angle -172^\circ$, 2fo: $0.73\angle 158^\circ$, 3fo: 0
 Load Γ : fo: $0.83\angle -173^\circ$, 2fo: $0.70\angle 175^\circ$, 3fo: 0

Power Tuned Data

Measured data provided by Modelithics.

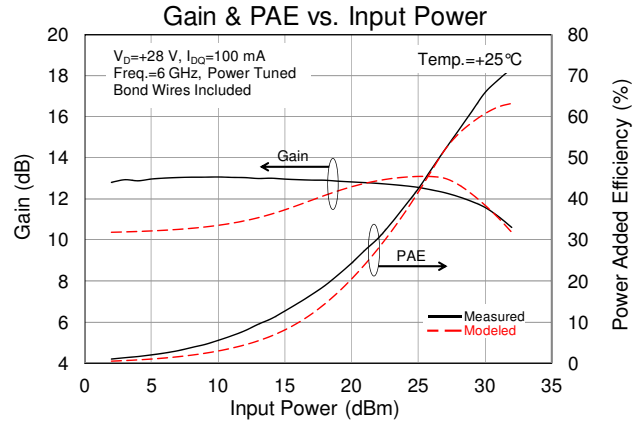
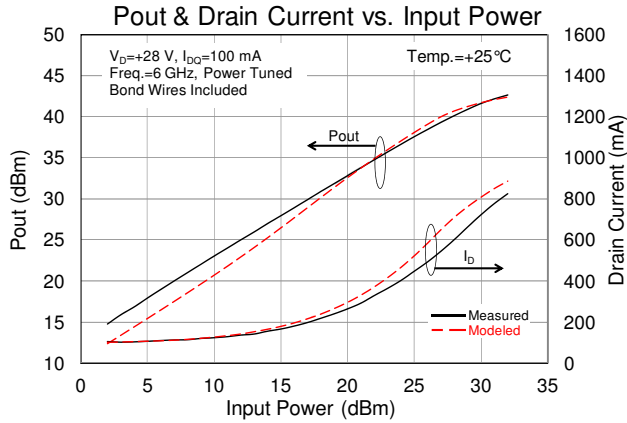

Source Γ : fo: $0.67\angle-172^\circ$, 2fo: $0.73\angle158^\circ$, 3fo: 0
 Load Γ : fo: $0.83\angle170^\circ$, 2fo: $0.67\angle144^\circ$, 3fo: 0

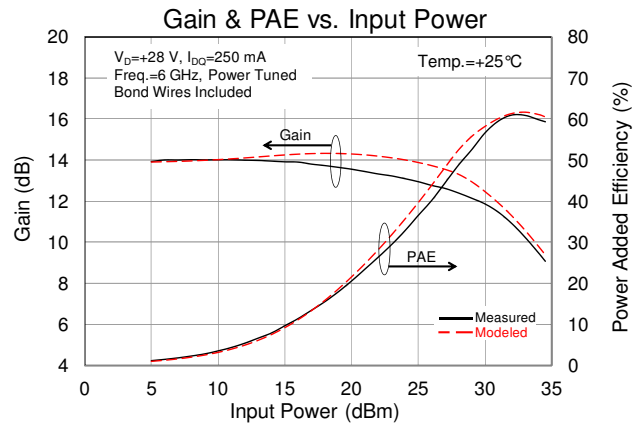
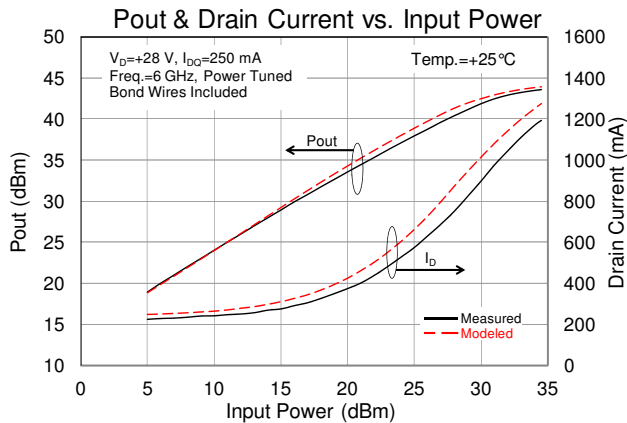

Source Γ : fo: $0.67\angle-172^\circ$, 2fo: $0.73\angle158^\circ$, 3fo: 0
 Load Γ : fo: $0.83\angle170^\circ$, 2fo: $0.67\angle144^\circ$, 3fo: 0

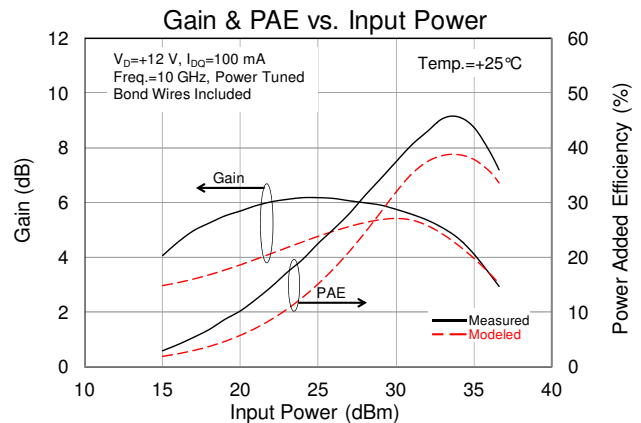
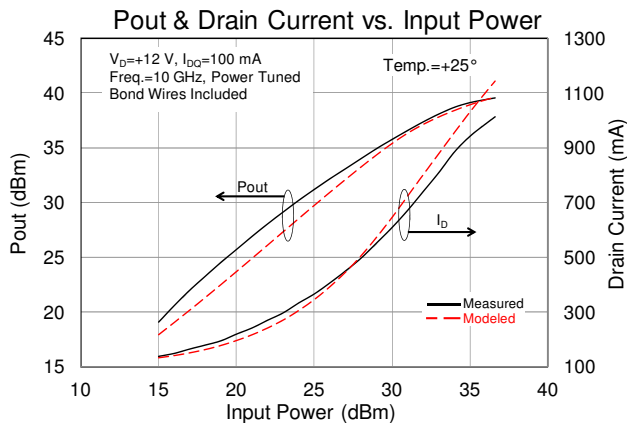

Source Γ : fo: $0.69\angle-151^\circ$, 2fo: $0.65\angle-172^\circ$, 3fo: $0.46\angle-175^\circ$
 Load Γ : fo: $0.82\angle-164^\circ$, 2fo: $0.77\angle167^\circ$, 3fo: $0.53\angle75^\circ$

Power Tuned Data

Measured data provided by Modelithics.

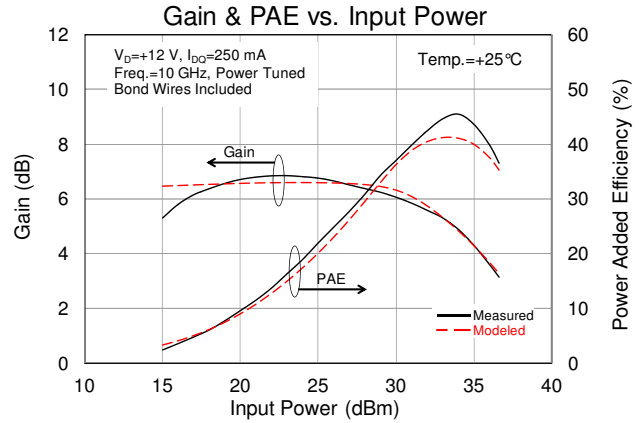
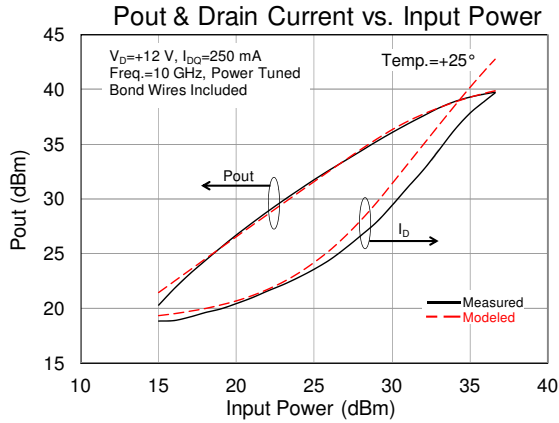

Source Γ : fo: $0.69\angle-151^\circ$, 2fo: $0.65\angle-172^\circ$, 3fo: $0.46\angle-175^\circ$
 Load Γ : fo: $0.82\angle-164^\circ$, 2fo: $0.77\angle 167^\circ$, 3fo: $0.53\angle 75^\circ$

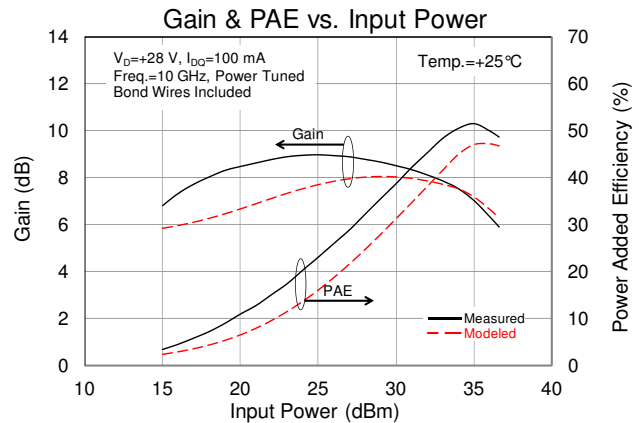
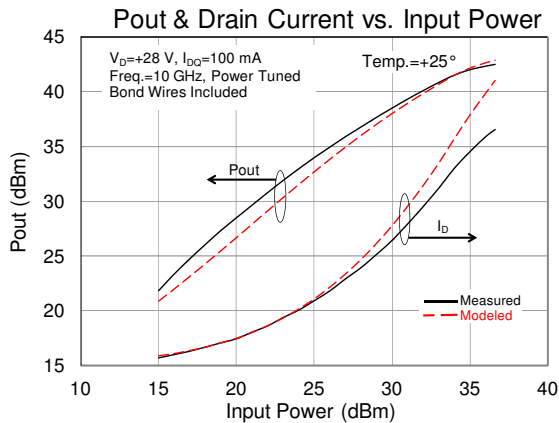

Source Γ : fo: $0.69\angle-152^\circ$, 2fo: $0.70\angle-161^\circ$, 3fo: $0.43\angle 167^\circ$
 Load Γ : fo: $0.81\angle-174^\circ$, 2fo: $0.77\angle 149^\circ$, 3fo: $0.51\angle 54^\circ$

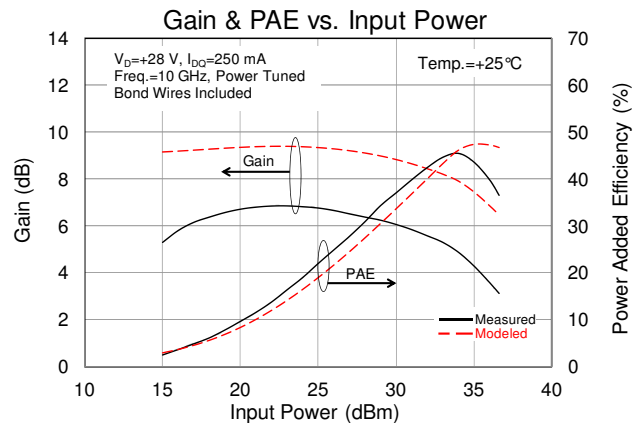
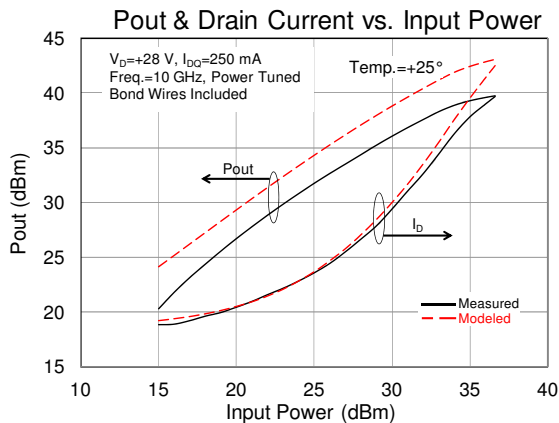

Source Γ : fo: $0.69\angle-152^\circ$, 2fo: $0.70\angle-161^\circ$, 3fo: $0.43\angle 167^\circ$
 Load Γ : fo: $0.81\angle-174^\circ$, 2fo: $0.77\angle 149^\circ$, 3fo: $0.51\angle 54^\circ$

Model

A non-linear model is available for download from Modelithics (at <http://www.modelithics.com/mvp/Triquint&tab=3>) by approved TriQuint customers. The model is compatible with the industry's most popular design software including Agilent ADS and National Instruments/AWR applications. Once on the Modelithics web page, the user will need to register for a free license before being granted the download.

Mechanical Drawing

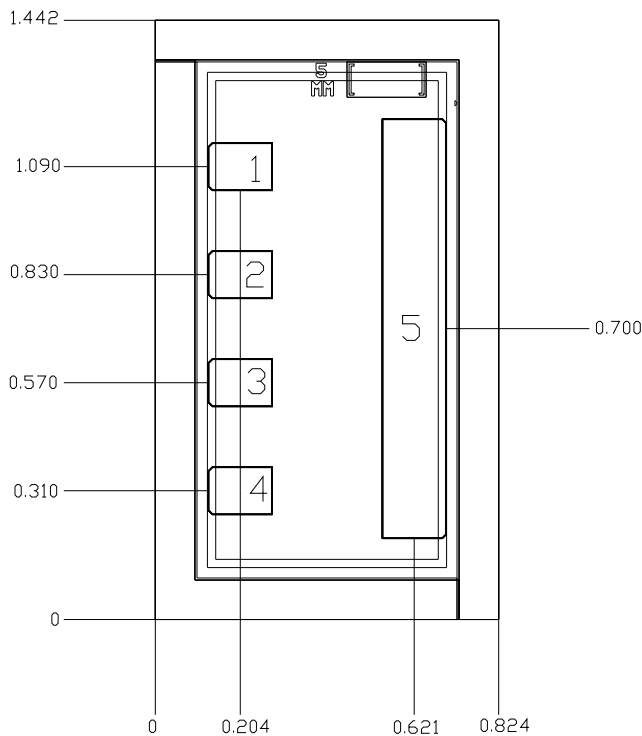

Bond Pads

Pad No.	Description	Dimensions
1-4	Gate	0.154 x 0.115
5	Drain	0.154 x 1.01
Die Backside	Source / Ground	0.824 x 1.442

Notes:

1. Units: millimeters
2. Thickness: 0.100 mm
3. Die x,y size tolerance: +/- 0.050 mm

Assembly Notes

Component placement and adhesive attachment assembly notes:

- Vacuum pencils and/or vacuum collets are the preferred method of pick up.
- Air bridges must be avoided during placement.
- The force impact is critical during auto placement.
- Organic attachment (i.e. epoxy) not recommended.

Reflow process assembly notes:

- Use AuSn (80/20) solder and limit exposure to temperatures above 300°C to 3-4 minutes, maximum.
- An alloy station or conveyor furnace with reducing atmosphere should be used.
- Do not use any kind of flux.
- Coefficient of thermal expansion matching is critical for long-term reliability.
- Devices must be stored in a dry nitrogen atmosphere.

Interconnect process assembly notes:

- Ball bonding is the preferred interconnect technique, except where noted on the assembly diagram.
- Force, time, and ultrasonics are critical bonding parameters.
- Aluminum wire should not be used.
- Devices with small pad sizes should be bonded with 0.0007-inch wire.

Disclaimer

GaN/SiC devices are susceptible to damage from Electrostatic Discharge. Proper precautions should be observed during handling, assembly and test.

Bias-up Procedure

1. V_G set to -5 V.
2. V_D set to 28 V.
3. Adjust V_G more positive until quiescent I_D is 500 mA.
4. Apply RF signal.

Bias-down Procedure

1. Turn off RF signal.
2. Turn off V_D and wait 1 second to allow drain capacitor dissipation.
3. Turn off V_G .

Product Compliance Information

ESD Sensitivity Ratings



Caution! ESD-Sensitive Device

ESD Rating: TBD
Value: TBD
Test: TBD
Standard: TBD

Solderability

Compatible with gold/tin (320°C maximum reflow temperature) soldering processes.

RoHS Compliance

This part is compliant with EU 2002/95/EC RoHS directive (Restrictions on the Use of Certain Hazardous Substances in Electrical and Electronic Equipment).

This product also has the following attributes:

- Lead Free
- Halogen Free (Chlorine, Bromine)
- Antimony Free
- TBBP-A (C₁₅H₁₂Br₄O₂) Free
- PFOS Free
- SVHC Free

Contact Information

For the latest specifications, additional product information, worldwide sales and distribution locations, and information about TriQuint:

Web: www.triquint.com

Email: info-sales@triquint.com

Tel: +1.972.994.8465

Fax: +1.972.994.8504

For technical questions and application information:

Email: info-products@triquint.com

Important Notice

The information contained herein is believed to be reliable. TriQuint makes no warranties regarding the information contained herein. TriQuint assumes no responsibility or liability whatsoever for any of the information contained herein. TriQuint assumes no responsibility or liability whatsoever for the use of the information contained herein. The information contained herein is provided "AS IS, WHERE IS" and with all faults, and the entire risk associated with such information is entirely with the user. All information contained herein is subject to change without notice. Customers should obtain and verify the latest relevant information before placing orders for TriQuint products. The information contained herein or any use of such information does not grant, explicitly or implicitly, to any party any patent rights, licenses, or any other intellectual property rights, whether with regard to such information itself or anything described by such information.

TriQuint products are not warranted or authorized for use as critical components in medical, life-saving, or life-sustaining applications, or other applications where a failure would reasonably be expected to cause severe personal injury or death.